

MLA2214012BXTH-R4096L-TKR2006xxxY

推力 : 8 N

瞬間推力 : 48 N

解析度 : 1.464 μm

連續移動速度 : 300 mm/s

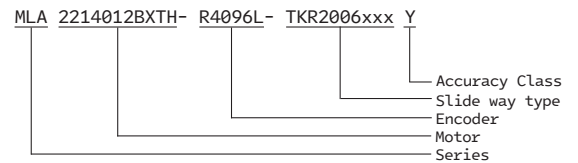
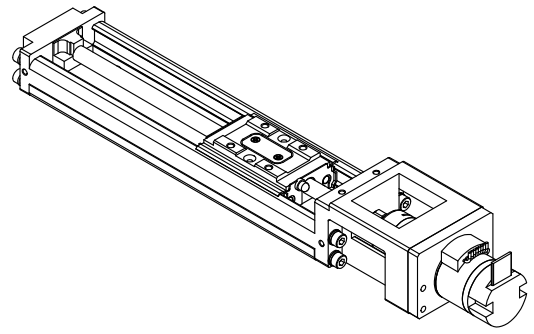

搭配組合 Faulhaber 微型直流伺服馬達與高剛性線軌模組
最緊湊體積下充分發揮空心杯馬達特性，完成高加減速，高速，高精度定位
搭配控制器做閉迴路力量，速度與位置控制，同時具備多種通訊界面供選擇

日本 THK 特規線軌模組
達高剛性、高穩定性與高重現性之特性

另可選配更高解析度，保護蓋，煞車器與極限開關

Technical Specification

Nominal voltage	24		V
Nominal current	0.65		A
Terminal resistance	6.95		Ω
Ballscrew pitch	6		mm
Operation temperature range	-20 ... +80		°C
Continuous force	8		N
Peak force	48		N
Continuous output speed, max	300		mm/s
Encoder resolution	4096		CPR
Linear resolution	1.464		μm
Accuracy class	H	P	
Accuracy	60	20	μm
Repeatability	±5	±3	μm
Slide guide backlash	10	3	μm

Slide way type	Stroke(mm)	L1 (mm)	L2 (mm)	N1 (mm)	S1xP1	N2 (mm)	S2xP2	Mass (kg)
TKR2006030	30	100	164	20	1x60	-	1x106	0.55
TKR2006080	80	150	214	15	2x60	-	1x156	0.68
TKR2006130	130	200	264	40	2x60	-	1x206	0.82

Dimensional drawing

Scale reduced mm

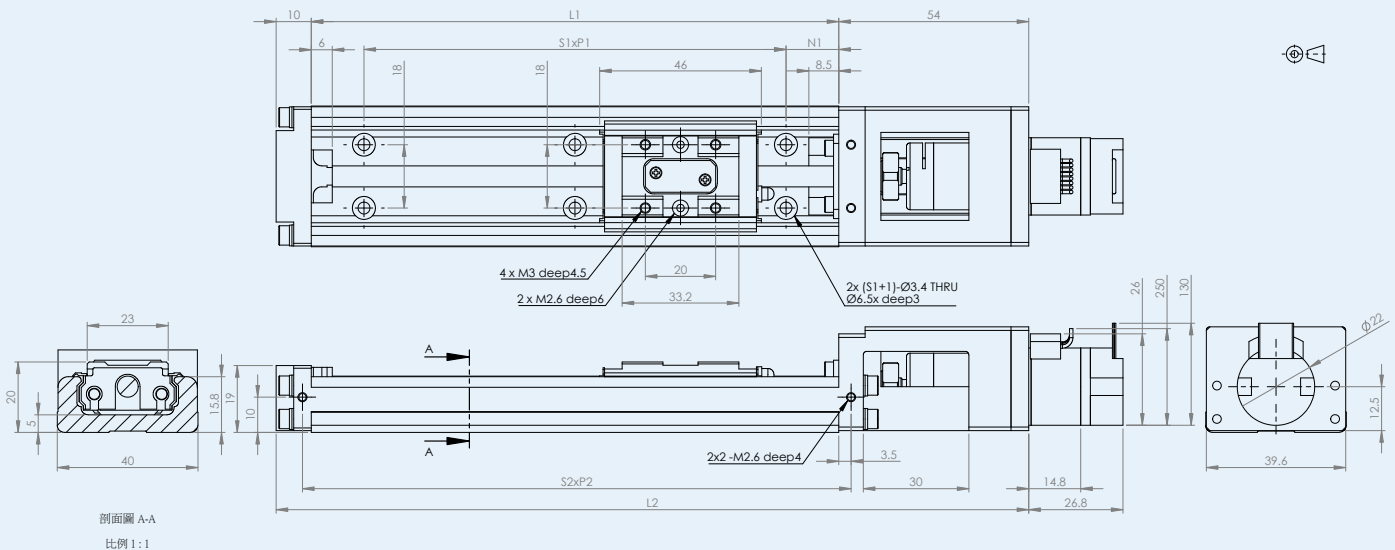

Motor Pin Assignment

Connector Type : MOLEX 43025-0800

Yellow	Phase C
Orange	Phase B
Brown	Phase A
Black	GND
Red	Um(+5V)
Grey	Hall sensor C
Blue	Hall sensor B
Green	Hall sensor A

Encoder Pin Assignment

Connector Type : DIN-41651

Pin 1	N.C.
Pin 2	UE
Pin 3	GND
Pin 4	N.C.
Pin 5	Ch A-
Pin 6	Ch A+
Pin 7	Ch B-
Pin 8	Ch B+
Pin 9	Ch I-
Pin 10	Ch I+

Option

Controller	Encoder	Brake	Cable
MC 3001 S RS/CO MC 3001 C RS/CO AEMT MC 3001 C PDIO MC 3001 C4 RS/CO MC 5004 C ET MC 5004 C ET AEMT	IE3-1024L IEF3-4096L IER3-10000L AEMT-12/16 L	PFB26E-24V	延長連接線組, 耐繞曲線組 請諮詢服務業務
			Others 保護蓋、雙滑塊、極限開關選配